



WE OFFER PERFECT MIXING TECHNOLOGIES

www.permixtec.com

Powder Blenders, Dryers, Paste Kneaders, Liquid Dispersers and Mixers.



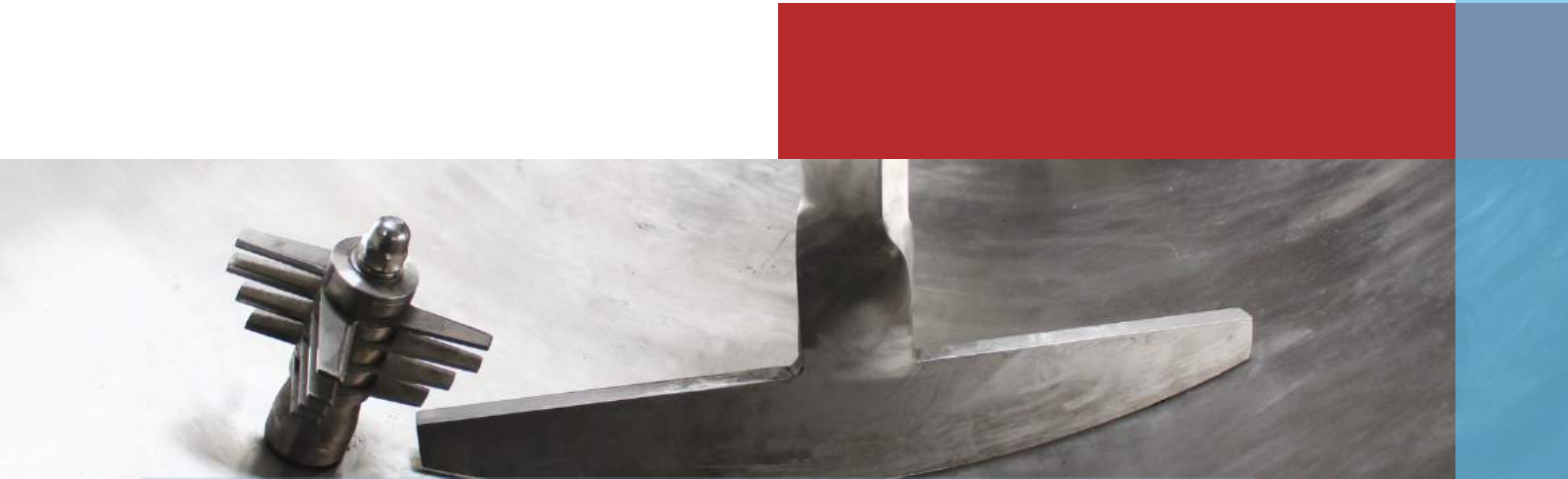

Present & Prospect



PRODUCT RANGE

We are able not only to offer the single machine with modern appearance and advanced technique, but also to offer the full line system to save your time, which is one of our strong points. With our engineers' decades of experience in this area, PerMix is capable to offer the most suitable solution for any industry that has a demand for mixing.



CUSTOMIZED SOLUTIONS

Despite a wide range of PerMix's standard mixing & processing equipment, we offer more options available, and PerMix designs its equipment according to the specific requirements of our customers. PerMix engineers evaluate the customer's mixing and processing problems in order to translate process parameters into soundly engineered and dependable mechanical equipment. PerMix welcomes the opportunity to discuss individual conditions and invites customers to compare and determine for themselves which equipment is best suited for their needs.



CUSTOMERS & APPLICATIONS

PerMix has been building a good reputation in both local and export markets over the years. No matter the customer is well-known or newly set up, PerMix serves them with full care. Our products are widely used to serve a variety of industries such as food, beverage, cosmetics, pharmaceuticals, biology, fine chemicals, specialty chemicals, animal feeds, agriculture, painting, ink, petrochemicals, nano materials, paper, adhesive, plastic, electronics, batteries, waste treatment, etc.



Product

Powder Blenders and Dryers

1. Ribbon Mixer
2. Ploughshare Mixer
3. Paddle Mixer
4. Fluidize Zone Mixer
5. Conical Screw Mixer
6. Vertical Ribbon Mixer
7. V Blender & Double Cone
8. High Speed Mixer
9. 3D Mixer
10. Drum Mixer
11. Vacuum Mixer Dryer
12. Nutsche Filter Dryer

1. Ribbon Mixer

PerMix PRB series Ribbon Mixer is an efficient and versatile blending machine for mixing of dry powders, granules and viscous pastes homogeneously.



Model	Total capacity (liter)	Useful capacity (liter)	Power (*) (kW)	RPM	L (mm)	W (mm)	H (mm)	Outlet (**)	Weight (kg)
PRB-100	100	40-60	2.2	80	1,250	840	613	80x80	250
PRB-300	300	120-180	4	72	1,630	1,005	1,015	250x80	600
PRB-500	500	200-300	5.5	65	2,030	1,175	1,140	360x120	850
PRB-1000	1,000	400-600	11	50	2,460	1,455	1,375	360x120	1,300
PRB-2000	2,000	800-1,200	18.5	38	3,050	1,710	1,545	360x120	2,300
PRB-3000	3,000	1,200-1,800	22	35	3,500	1,865	1,680	360x120	3,300
PRB-4000	4,000	1,600-2,400	22	35	3,870	1,985	1,821	500x120	3,600
PRB-5000	5,000	2,000-3,000	30	30	4,090	2,062	1,945	500x120	4,620
PRB-6000	6,000	2,400-3,600	37	27	4,250	1,802	2,380	500x120	5,300
PRB-8000	8,000	3,200-4,800	45	24	4,590	1,956	2,504	700x120	6,800
PRB-10000	10,000	4,000-6,000	55	24	5,050	2,016	2,800	700x140	8,900
PRB-12000	12,000	4,800-7,200	55	20	5,500	2,160	2,753	700x140	9,520
PRB-15000	15,000	6,000-9,000	75	20	5,900	2,170	2,910	700x140	9,950
PRB-20000	20,000	8,000-12,000	90	17	7,180	2,690	2,830	700x140	13,500
PRB-25000	25,000	10,000-15,000	110	12	7,990	2,730	3,100	700x140	17,500
PRB-30000	30,000	12,000-18,000	132	12	8,450	2,860	3,300	700x140	19,500

1. (*) (**): Changes are available according to the customer's request.

2. All specifications and illustrations are as accurate as is reasonably possible, but they are not binding.

3. PerMix reserves the right to modify the design without notice.

2. Ploughshare Mixer

PerMix PTS Ploughshare Mixer is a versatile machine that can handle nearly all types of materials including drying material, powdery granular, short fibered substance, moist solids with liquids, pasty material and highly viscous masses.



Model	Total capacity (liter)	Working capacity (liter)	Power (*) (kW)	Speed (rpm)	L1 (mm)	L (mm)	W (mm)	H1 (**)(mm)	H (***)(mm)
PTS-5L	5	3	1.1	0-582	180	800	500	-	-
PTS-10L	10	7	1.1	0-582	200	900	500	-	-
PTS-45	45	30	2.2	223	480	900	550	450	950
PTS-70	70	45	2.2	190	580	1,050	600	450	970
PTS-100	100	70	3	170	660	1,100	610	450	1,020
PTS-200	200	140	5.5	149	890	1,400	730	500	1,180
PTS-300	300	210	7.5	129	970	1,550	850	500	1,300
PTS-500	500	350	11	118	1,250	2,000	950	500	1,400
PTS-750	750	500	15	103	1,500	2,250	1,100	600	1,600
PTS-1000	1,000	700	22	101	1,900	2,600	1,150	600	1,800
PTS-1500	1,500	1,000	30	85	2,110	3,200	1,200	600	2,000
PTS-2000	2,000	1,400	45	72	2,110	3,500	1,350	600	2,200
PTS-3000	3,000	2,100	55	67	3,000	4,100	1,500	800	2,400
PTS-4000	4,000	2,800	75	62	3,000	4,200	1,550	800	2,600
PTS-5000	5,000	3,500	75	54	3,000	4,300	1,620	800	2,800

1. PTS-L: laboratory size

2. (*) (**) (***): Changes are available according to the customer's request.

3. All specifications and illustrations are as accurate as is reasonably possible, but they are not binding.

4. PerMix reserves the right to modify the design without notice.

3. Paddle Mixer

PerMix PTP series Paddle Mixer is an innovative design of the conventional Ploughshare Mixer, but it generates gentler mixing (for turbulence sensitivity particles) and requires less power consumption.



Model	Total capacity (liter)	Working capacity (liter)	Power (*) (kW)	Speed (rpm)	L1 (mm)	L (mm)	W (mm)	H1 (**)(mm)	H (***)(mm)
PTP-5L	5	3	1.1	0-582	180	800	500	-	-
PTP-10L	10	7	1.1	0-582	200	900	500	-	-
PTP-45	45	30	0.75	81	480	900	550	450	950
PTP-70	70	45	0.75	69	580	1,050	600	450	970
PTP-100	100	70	1.1	60	660	1,100	610	450	1,020
PTP-200	200	140	1.5	53	890	1,400	730	500	1,180
PTP-300	300	210	2.2	51	970	1,550	850	500	1,300
PTP-500	500	350	4	45	1,250	2,000	950	500	1,400
PTP-750	750	500	5.5	45	1,500	2,250	1,100	600	1,600
PTP-1000	1,000	700	7.5	33	1,900	2,600	1,150	600	1,800
PTP-1500	1,500	1,000	11	28	2,110	3,200	1,200	600	2,000
PTP-2000	2,000	1,400	15	25	2,110	3,500	1,350	600	2,200
PTP-3000	3,000	2,100	22	23	3,000	4,100	1,500	800	2,400
PTP-4000	4,000	2,800	30	17	3,000	4,200	1,550	800	2,600
PTP-5000	5,000	3,500	37	17	3,000	4,300	1,620	800	2,800

1. PTP-L: laboratory size

2. (*) (**) (***): Changes are available according to the customer's request.

3. All specifications and illustrations are as accurate as is reasonably possible, but they are not binding.

4. PerMix reserves the right to modify the design without notice.

4. Fluidize Zone Mixer

PerMix PFB series Fluidize Zone Mixer is capable of preparing a homogeneous mixture despite of particle size, shape and density, and is able to achieve fast, high capacity, thorough, precision mixing of either dry bulk solids or solid with liquid.



Model	Total capacity (liter)	Working capacity (liter)	Power (*) (kW)	L (mm)	W (mm)	H (mm)	Inlet (**) (mm)	Outlet (***) (mm)	Weight (kg)
PFB-50	50	20-30	0.75-2.2	-	-	-	-	-	250
PFB-150	150	60-90	1.5-4	-	-	-	-	-	300
PFB-300	300	120-180	3-4	1,242	1,278	1,025	1-Φ400	350X40	750
PFB-500	500	200-300	4-7.5	1,408	1,478	1,305	1-Φ400	500X90	1,000
PFB-1000	1,000	400-600	7.5-15	1,875	1,692	1,425	1-Φ500	500X90	1,550
PFB-2000	2,000	800-1,200	15-22	2,275	2,108	1,775	1-Φ500	500X90	2,500
PFB-3000	3,000	1,200-1,800	18.5-30	2,408	2,396	1,955	1-Φ500	500X90	2,900
PFB-4000	4,000	1,600-2,400	22-37	2,822	2,546	2,015	1-Φ500	500X90	3,600
PFB-6000	6,000	2,400-3,600	30-45	3,050	2,980	2,235	1-Φ500	500X90	5,600
PFB-8000	8,000	3,200-4,800	37-55	3,362	3,412	2,425	1-Φ500	800X200	7,100
PFB-10000	10,000	4,000-6,000	45-75	3,538	3,645	2,615	1-Φ500	800X200	8,000

1. (*) (**) (***): Changes are available according to the customer's request.
2. All specifications and illustrations are as accurate as is reasonably possible, but they are not binding.
3. PerMix reserves the right to modify the design without notice.

5. Conical Screw Mixer

PerMix PNA series Conical Screw Mixer is a batch mixing equipment used widely in applications that require gentle mixing and minimal heat generation without any product distortion.



Model	Total volume (liter)	Working volume (liter)	Power (*) (kW)	RPM	Dia. (mm)	H, total height (**) (mm)	Inlet (***) (mm)	Outlet (****) (mm)	Weight (kg)
PNA-50	50	30	1.5+0.18	117/2	660	1400	90	150	150
PNA-100	100	60	1.5+0.18	117/2	720	1500	100	200	300
PNA-200	200	120	2.2+0.37	140/2	888	1557	140	230	500
PNA-300	300	180	2.2+0.37	140/2	990	1722	180	230	550
PNA-500	500	300	3+0.37	140/2	1156	1991	200	230	600
PNA-800	800	480	4+0.55	60/2	1492	2256	250	300	950
PNA-1000	1000	600	4+0.55	60/2	1600	2432	300	300	1200
PNA-1500	1500	900	5.5+0.55	60/2	1780	2725	300	300	1350
PNA-2000	2000	1200	5.5+0.55	60/2	1948	3001	350	350	1500
PNA-2500	2500	1500	7.5+1.1	60/2	2062	3024	350	350	1800
PNA-3000	3000	1800	7.5+1.1	60/2	2175	3207	350	350	2100
PNA-4000	4000	2400	11+1.5	40/2	2435	4010	400	400	2500
PNA-5000	5000	3000	15+2.2	40/2	2578	4260	400	400	3000
PNA-6000	6000	3600	18.5+2.2	40/2	2715	4470	400	400	3500
PNA-8000	8000	4800	22+3	40/1.3	2792	5000	400	450	3800
PNA-10000	10000	6000	30+4	40/1.3	3000	5240	500	450	4300

1. (*) (**) (***) (****): Changes are available according to the customer's request.

2. Customized sizes available as per request

3. All specifications and illustrations are as accurate as is reasonably possible, but they are not binding.

4. PerMix reserves the right to modify the design without notice.

6. Vertical Ribbon Mixer

PerMix PVR series Vertical Ribbon Blender has a similar appearance with the popular Ribbon Blender, but stands vertically. It is an efficient and versatile blending machine for batch mixing of free-flowing powders.

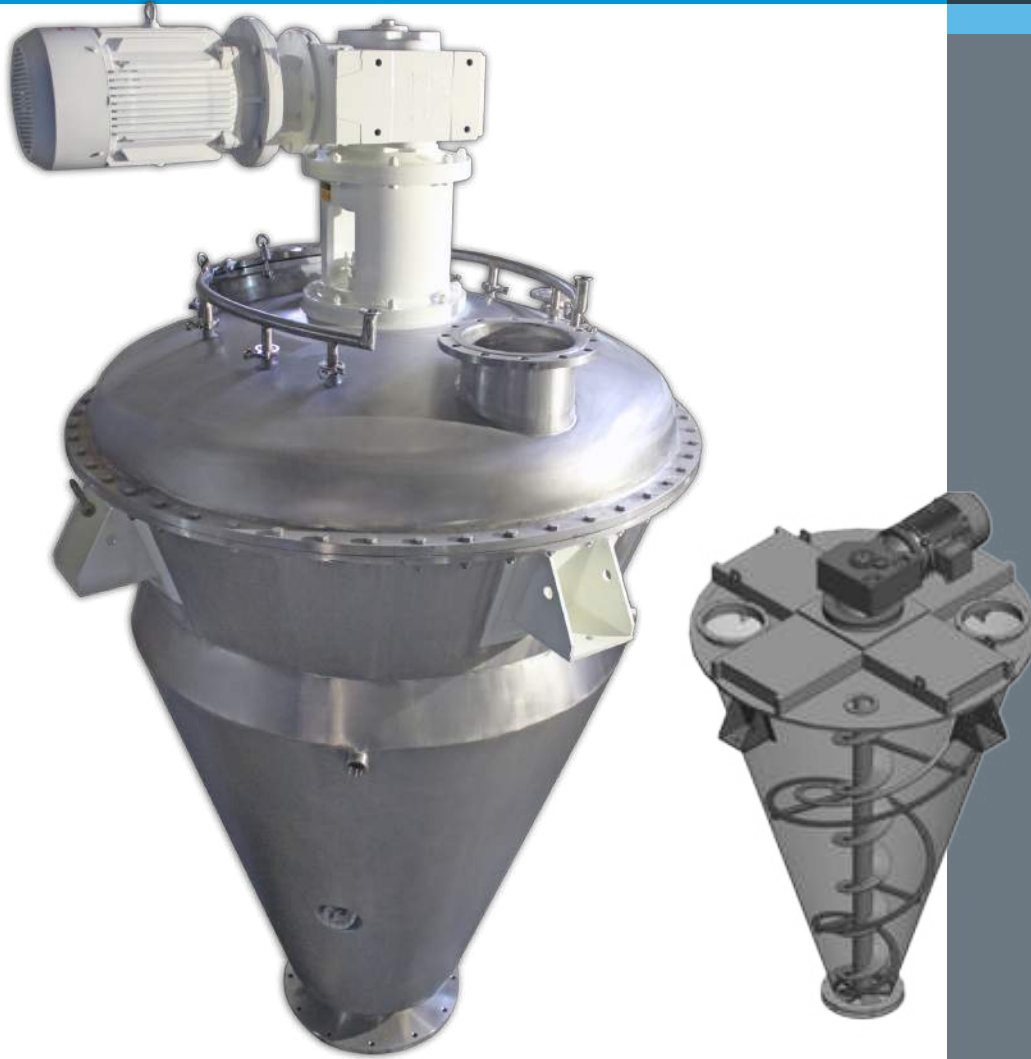

Model	Total capacity (liter)	Working capacity (liter)	Power (*) (kW)	Diameter (mm)	H, total height (**) (mm)	Inlet (***) (mm)	Outlet (****) (mm)	Weight (kg)
PVR-100	100	70	1.5-2.2	708	1420	140	150	180
PVR-300	300	210	2.2-5.5	990	1998	180	230	460
PVR-500	500	350	4-7.5	1156	2268	200	230	510
PVR-1000	1000	700	5.5-11	1600	2742	300	300	1020
PVR-1500	1500	1050	7.5-15	1780	2580	300	300	1100
PVR-2000	2000	1400	11-18.5	1948	2825	350	300	1270
PVR-2500	2500	1750	15-22	2062	3020	350	400	1530
PVR-3000	3000	2100	18.5-22	2175	3200	350	400	1780

1. (*) (**) (***) (****): Changes are available according to the customer's request.
2. All specifications and illustrations are as accurate as is reasonably possible, but they are not binding.
3. PerMix reserves the right to modify the design without notice.

7. V Blender & Double Cone

PerMix PVM series V Blender and PDC series Double Cone Blender are unique mixers suitable for rapid and uniform mixing of free flowing dry powders, granules and crystals.



Model	Total, Liter	Working, Liter	Power, kW	Length, mm	Width, mm	Height, mm	Operation Height, mm
PDC-5	5	3	0.25	800	500	660	750
PDC-15	15	7	0.37	600	430	1,265	1,335
PDC-45	45	20	0.55	850	620	1,540	1,650
PDC-100	100	50	0.75	1,100	810	1,620	1,950
PDC-200	200	100	1.1	1,400	1,020	2,100	2,280
PDC-300	300	150	1.5	1,600	1,160	2,320	2,530
PDC-500	500	250	2.2	1,630	1,070	2,600	2,600
PDC-700	700	350	3	1,820	1,200	2,770	2,770
PDC-1000	1,000	500	4	2,100	1,350	2,985	2,985
PDC-2000	2,000	1,000	5.5	2,620	1,350	2,145	2,280
PDC-3000	3,000	1,500	7.5	2,990	1,550	2,440	2,600
PDC-4000	4,000	2,000	11	3,280	1,680	2,685	2,850
PDC-5000	5,000	2,500	15	3,530	1,810	2,890	3,070

1. All specifications are as accurate as is reasonably possible, but they are not binding.
2. Customized sizes are available against request.
3. PerMix reserves the right to modify the design without notice.

7. V Blender & Double Cone

PerMix PVM series V Blender and PDC series Double Cone Blender are unique mixers suitable for rapid and uniform mixing of free flowing dry powders, granules and crystals.



Model	Total Vol., Liter	Operation Vol., Liter	Power, kW	Length, mm	Width, mm	Height, mm	Operation Height, mm
PVM-5	5	3	0.25	810	500	660	770
PVM-15	15	7	0.37	700	525	1,100	1,150
PVM-45	45	20	0.55	1,000	760	1,300	1,400
PVM-100	100	50	0.75	1,200	990	1,500	1,630
PVM-200	200	100	1.1	1,560	1,240	1,715	1,890
PVM-300	300	150	1.5	1,750	1,400	1,900	2,000
PVM-500	500	250	2.2	2,200	1,600	2,550	2,825
PVM-700	700	350	3	2,400	1,900	2,720	2,970
PVM-1000	1,000	500	4	2,670	2,120	2,850	3,150
PVM-2000	2,000	1,000	5.5	3,550	2,680	2,280	2,660
PVM-3000	3,000	1,500	7.5	4,050	3,060	2,620	3,050
PVM-4000	4,000	2,000	11	4,450	3,350	2,880	3,300
PVM-5000	5,000	2,500	15	4,800	3,570	3,070	3,550

1. All specifications are as accurate as is reasonably possible, but they are not binding.
2. Customized sizes are available against request.
3. PerMix reserves the right to modify the design without notice.

8. High Speed Mixer

PerMix PDI series High Speed Mixer is an efficient and versatile blending machine for mixing of dry powders, or granulating with the addition of liquid binder, within a very short time and with excellent cleaning abilities.



Model	Total Volume, [Liter]	Operation Volume, [Liter]	Impeller Power, [kW]	Impeller Speed, [rpm]	Chopper Power, [kW]	Chopper Speed, [rpm]
PDI-10	10	6	2.2	381	1.1	1,500
PDI-50	50	30	4	288	1.1	1,500
PDI-100	100	60	5.5	277	1.5	1,500
PDI-200	200	120	7.5	193	3	1,500
PDI-300	300	180	11	176	4	1,500
PDI-400	400	240	15	176	5.5	1,500
PDI-600	600	360	22	149	5.5	1,500
PDI-800	800	480	30	124	7.5	1,500
PDI-1000	1,000	600	37	116	11	1,500
PDI-1500	1,500	900	55	99	18.5	1,500

1. All specifications are as accurate as is reasonably possible, but they are not binding.
2. Customized sizes are available against request.
3. PerMix reserves the right to modify the design without notice.

9. 3D Mixer

PerMix PTU series 3D Mixer is used for homogeneous mixing of powdery substances with different specific weights and particle sizes. Producing dry-to-wet and wet-to-wet mixtures is also possible.

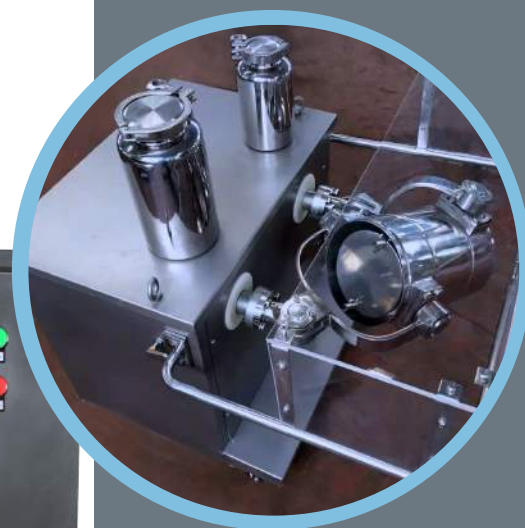

Model	Total Volume, Liter	Operation Volume, Liter	Power, kW	Speed of Mixing Can, rpm	Length, mm	Width, mm	Height, mm	Weight, kg
PTU-5	5	4	0.25	28	600	1000	900	150
PTU-15	15	12	0.37	20	700	1000	1000	200
PTU-50	50	40	1.5	15	1120	1330	1220	500
PTU-100	100	80	2.2	12	1370	1550	1430	700
PTU-300	300	240	4	8	2000	2400	2100	1600

1. All specifications are as accurate as is reasonably possible, but they are not binding.
2. Bigger sizes up to 1,000L are available against request.
3. PerMix reserves the right to modify the design without notice.

10. Drum Mixer

PerMix PDR series Drum Mixer is developed to meet demands for a low batch mixer for mixing, blending, homogenizing, dyeing of dry powders and granules particularly in smaller industries or when frequent product changes as required.



Model	Total Volume, Liter	Operation Volume, Liter	Max. Loading Weight, kg	Power, kW	Speed of Drum Hoop, rpm	L, mm	W, mm	H, mm	Weight, kg
PDR-50	50	35	30	0.55	15	1350	670	1185	130
PDR-100	100	70	60	0.55	15	1350	670	1185	130
PDR-200	200	140	120	0.55	15	1350	670	1185	130

1. All specifications are as accurate as is reasonably possible, but they are not binding.
2. Length, width, height, weight are without the drum.
3. Customized sizes are available against request.
4. PerMix reserves the right to modify the design without notice.

11. Vacuum Mixer Dryer

PerMix PTP-D series Vacuum Mixer Dryer is a turbulent mixing reactor-dryer. It is used as a high-speed paddle dryer, chemical reactor or, if both processes are combined, as a dryer-reactor.



12. Nutsche Filter Dryer

PerMix PNF series Nutsche Filter Dryer is specially designed for solid - liquid separation and drying. It is able to process a concentrated slurry and discharge dry powders.

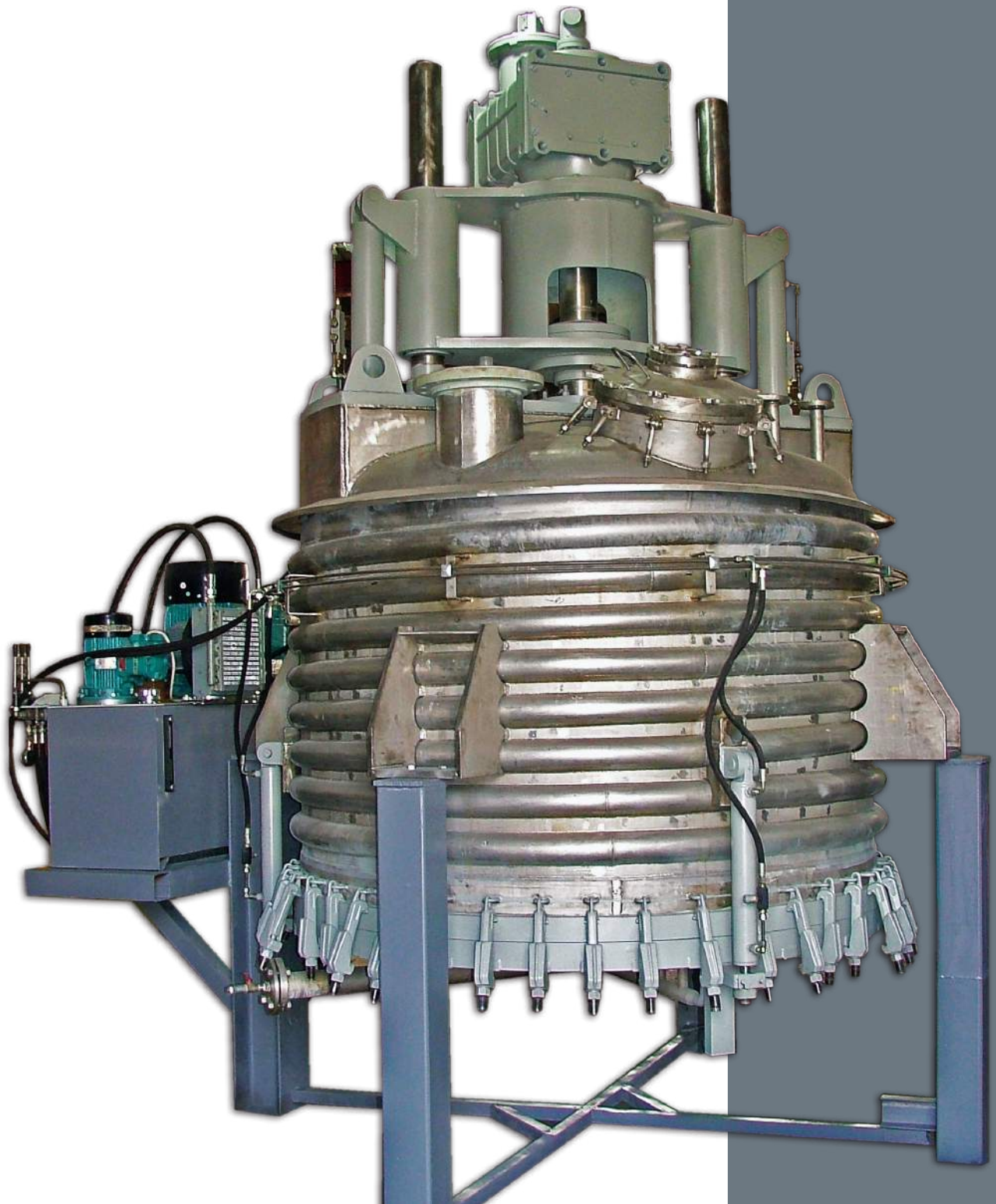



Product

Paste Kneaders and Mixers

1. Sigma Kneader Mixer
2. Double Planetary Mixer
3. Multi-shaft Mixer
4. Vacuum Emulsifier Mixer
5. High Speed Disperser

1. Sigma Kneader Mixer

With its unique design of Z-shaped mixing tools installed in two semi-cylinders, PerMix PSG series Sigma Kneader is used for the mixing-kneading of materials with very high viscosities (over 500,000 cps).

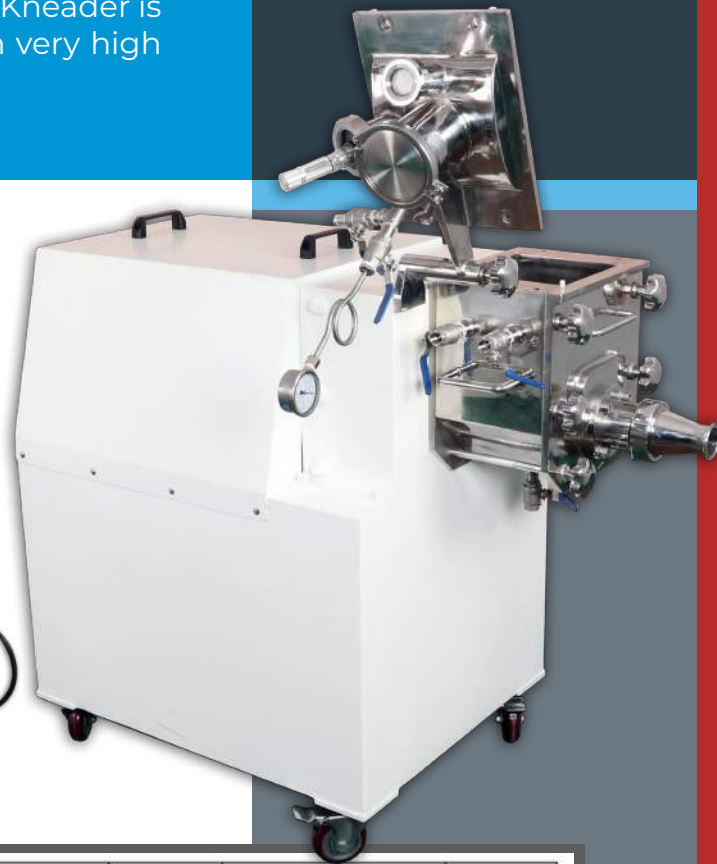

Model	Total Capacity (liters)	Working Capacity (liters)	Power for Arms, kW (high viscosity)	Power for Arms, kW (very high viscosity)	Arm Speed, rpm	Length (mm)	Width (mm)	Height (mm)
PSG-1	1	0.6	1.1	2.2	60/47	550	450	700
PSG-3	3	2	1.1	2.2	65/40	650	500	700
PSG-5	5	3.5	1.1	2.2	65/40	700	550	730
PSG-10	10	6	1.5	3	50/35	900	580	691
PSG-15	15	10	2.2	5	50/28	1053	623	861
PSG-50	50	30	3~5.5	5.5~11	43/27	1330	910	1350
PSG-100	100	60	5.5~7.5	11~15	40/25	1588	984	1452
PSG-150	150	90	5.5~11	11~15	40/25	1780	990	1600
PSG-200	200	120	7.5~15	15~22	41/26	1988	1000	1829
PSG-300	300	180	7.5~22	15~30	33/22	2730	1930	1745
PSG-400	400	240	11~30	22~37	33/22	2850	1950	1800
PSG-600	600	360	30~37	55~75	35/23	3070	2080	1870
PSG-800	800	480	30~45	55~90	32/21	3270	2250	1950
PSG-1000	1000	600	37~55	75~110	32/21	4080	1560	2055
PSG-1500	1500	900	45~75	90~160	29/19	4600	1700	2330
PSG-2000	2000	1200	55~75	110~160	29/19	5100	1850	2600

- 1) All specifications are as accurate as is reasonably possible, but they are not binding.
- 2) Arms speed can be specified by the customer.
- 3) Customized sizes are available against request.
- 4) PerMix reserves the right to modify the design without notice.

1. Sigma Kneader Mixer

PerMix PSG-X Sigma Mixer Extruder (or Mixtruder) is designed with an extrusion screw located in a cylindrical barrel in the middle and below the two mixing arms. The extrusion screw is used to discharge the product, but can also runs in reversed direction during mixing cycle, lifting materials up to the reach of mixing arms, thus assuring a thorough kneading and accelerating the mixing process. The screw has its own separate drive.



Model	Total Capacity (liters)	Working Capacity (liters)	Power for Arms, kW (high viscosity)	Power for Arms, kW (very high viscosity)	Arm Speed, rpm	Power for Screw, kW (high viscosity)	Power for Screw, kW (very high viscosity)	Screw Speed, rpm
PSG-1X	1	0.6	1.1	2.2	60/47	0.55	1.1	59
PSG-3X	3	2	1.1	2.2	60/47	0.55	1.1	59
PSG-5X	5	3.5	1.1	2.2	60/47	0.55	1.1	59
PSG-10X	10	6	1.5	3	53/38	0.75	1.5	60
PSG-15X	15	10	2.2	5	50/28	1.1	2.2	60
PSG-50X	50	30	3~5.5	5.5~11	43/27	1.5	3	58
PSG-100X	100	60	5.5~7.5	11~15	40/25	3	4	58
PSG-150X	150	90	5.5~11	11~15	40/25	3	5.5	57
PSG-200X	200	120	7.5~15	15~22	41/26	3	5.5	51
PSG-300X	300	180	7.5~22	15~30	33/22	4	7.5	51
PSG-400X	400	240	11~30	22~37	33/22	5.5	11	51
PSG-600X	600	360	30~37	55~75	35/23	11	30	53
PSG-800X	800	480	30~45	55~90	32/21	11	30	53
PSG-1000X	1000	600	37~55	75~110	32/21	15	37	50
PSG-1500X	1500	900	45~75	90~160	29/19	18.5	45	45
PSG-2000X	2000	1200	55~75	110~160	29/19	22	55	45

2. Double Planetary Mixer

PerMix PDP series Double Planetary Mixer is designed to mix, knead, stir and deaerate all types of material, including highly viscous pastes, even to granulate wet powders.



Model	Total volume (liter)	Working volume (liter)	Motor (kW)	Lifting power (kW)	Length (mm)	Width (mm)	Height [closed] (mm)	Height [open] (mm)
PDP-3	3.5	2	0.75	-	950	500	1,500	-
PDP-10	10	6	1.5	-	1,000	500	1,650	-
PDP-30	30	20	4	1.1	1,250	700	1,350	1,750
PDP-50	50	35	5.5	1.1	1,300	800	1,450	1,900
PDP-100	100	70	7.5	1.5	1,550	700	1,450	1,950
PDP-200	200	140	11	2.2	1,850	800	1,700	2,300
PDP-300	300	210	15	2.2	1,900	900	1,700	2,350
PDP-500	500	350	30	4	2,400	1,050	2,000	2,800
PDP-750	750	520	37	4	2,750	1,200	2,400	3,300
PDP-1000	1,000	700	45	5.5	2,800	1,650	2,450	3,300

- 1) All specifications are as accurate as is reasonably possible, but they are not binding.
- 2) Customized sizes are available against request.
- 3) PerMix reserves the right to modify the design without notice.

3. Multi-shaft Vacuum Mixer

PerMix PMS series Multi-shaft Vacuum Mixer is a revolutionary universal multi-processing mixer which is designed to serve a wide variety of industries in many different processes.



Model	Total volume, liter	Working volume, liter	Emulsifying motor, kW	Scraper motor, kW	Lifting motor, kW	Length (mm)	Width (mm)	Height [closed] (mm)	Height [open] (mm)
PMS-10	13	10	0.37	0.37	-	1,050	450	1,000	-
PMS-20	25	20	0.37	0.55	-	1,070	650	1,250	-
PMS-50	70	50	0.75	0.75	0.75	1,300	720	1,550	2,000
PMS-100	125	100	1.5	1.5	0.75	1,500	1,200	1,600	2,100
PMS-150	180	150	2.2	2.2	0.75	1,650	1,250	1,650	2,300
PMS-200	230	200	4	3	1.1	1,700	1,300	1,650	2,350
PMS-300	350	300	5.5	4	1.1	1,850	1,350	1,650	2,450
PMS-500	580	500	7.5	5.5	1.1	2,200	1,600	1,900	2,800
PMS-750	900	750	11	7.5	1.5	2,400	1,650	2,200	3,400
PMS-1000	1,200	1,000	15	11	1.5	2,600	1,800	2,500	3,700

1. All specifications are as accurate as is reasonably possible, but they are not binding.
2. Customized sizes are available against request.
3. PerMix reserves the right to modify the design without notice.

4. Vacuum Emulsifier Mixer

PerMix PVC series Vacuum Emulsifier Mixer is more than a single homogenizer, but a vacuum mixing, dispersing and homogenizing system that is used whenever a high quality and absolutely air-free product is required.



Model	Total volume, liter	Working volume, liter	Emulsifying motor, kW	Scraper motor, kW	Length (mm)	Width (mm)	Height [closed] (mm)	Height [open] (mm)
PVC-8	10	8	2.2	0.25	-	-	-	-
PVC-50	70	50	4	0.37	-	-	-	-
PVC-100	125	100	7.5	0.55	870	650	1,300	1,710
PVC-150	180	150	11	0.55	950	720	1,450	1,990
PVC-300	350	300	18.5	1.1	1,260	930	1,850	2,610
PVC-500	580	500	30	1.1	1,500	1,100	2,180	3,160
PVC-1000	1,200	1,000	55	2.2	2,040	1,390	2,750	3,660

- 1) All specifications are as accurate as is reasonably possible, but they are not binding.
- 2) Customized sizes are available against request.
- 3) PerMix reserves the right to modify the design without notice.

5. High Speed Dispenser

PerMix PD series High Speed Dispenser is ideally designed to meet the high speed dispersing demands of a broad spectrum of industrial applications.



Model	Working Volume (liter)	Main Motor (kW)	Max. Shaft Speed (rpm)	Overall Dimension					Weight (kg)
				L (mm)	W (mm)	H (mm)	H (lifted) (mm)	Disc Dia. (mm)	
PD-5L *	2-5	0.55	0-10,000	460	420	740	990	50/60	30
PD-70 *	70	1.5/2.2	3,000	680	775	1410	1910	120/100	140
PD-100	100	3	2,100	950	400	1500	2100	150/100	200
PD-200	200	5.5	2,100	1400	700	1750	2550	200/150	500
PD-300	300	7.5	2,100	2200	1100	2100	3100	250/200	1200
PD-500	500	11	1,500	2200	1100	2100	3100	300/250	1300
PD-700	700	18.5	1,500	2400	1300	2200	3300	350/300	1400
PD-1000	1000	22	1,500	2500	1400	2200	3300	400/300	1600
PD-1200	1200	30	1,500	2800	1600	2500	3700	425/350	1900
PD-2000	2000	37	1,500	2800	1600	2500	3700	500/425	2100
PD-3000	3000	55	1,500	3400	2200	3000	4500	625/500	2400
PD-4000	4000	75	1,000	3400	2200	3000	4500	700/625	2600
PD-6000	6000	110	1,000	3800	2400	3200	4800	800/700	3100

- 1) Dimension/Weight information of PD-5L/PD-70 includes the manual lifting stand.
- 2) Specific working volumes can be offered according to customer's requirement.
- 3) All specifications and illustrations are as accurate as is reasonably possible, but they are not binding.
- 4) PerMix reserves the right to modify the design without notice.

*Liquid Dispersers
and Mixers*

PERFECT FLUID MIXING

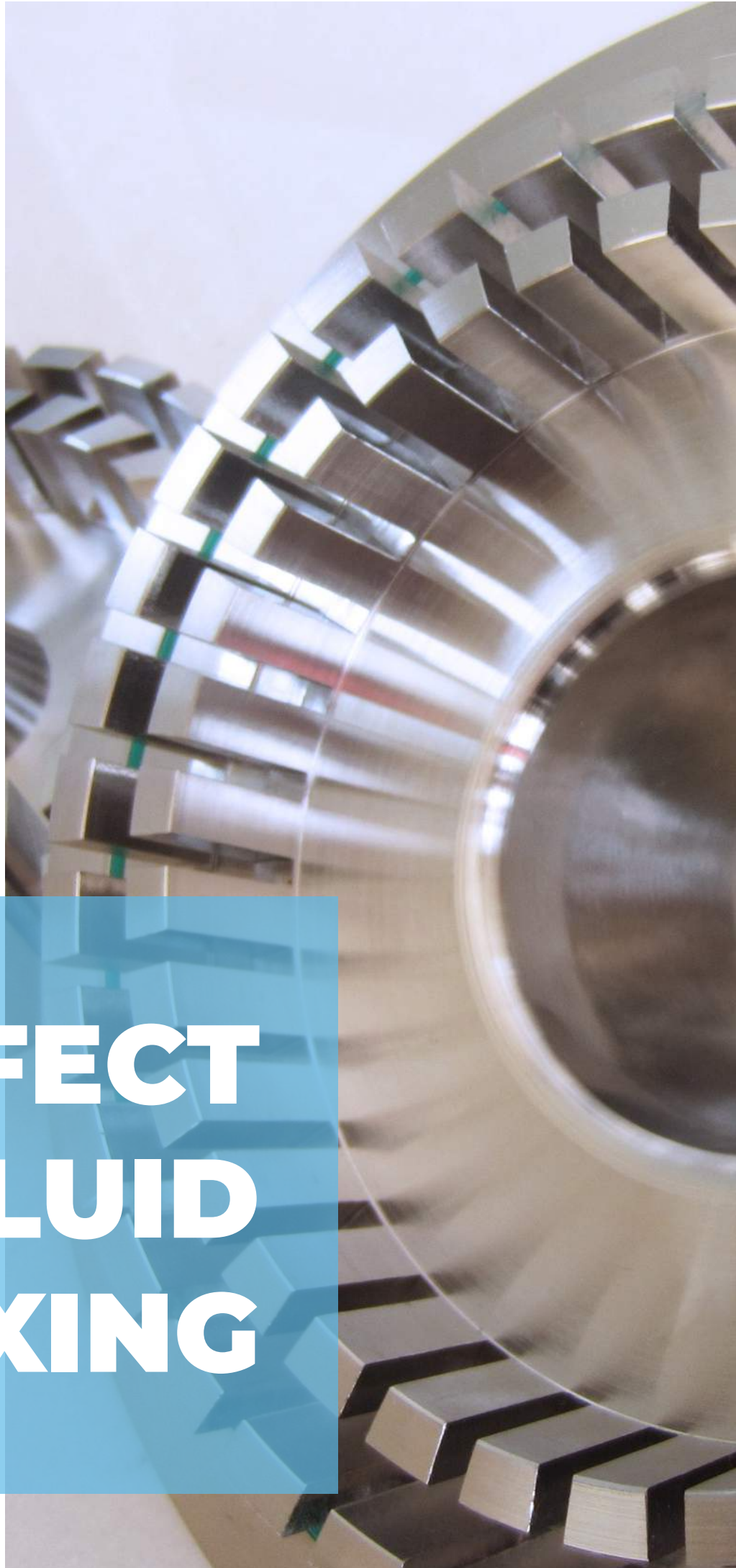



Product

Liquid Dispersing & Mixing

1. High Shear Mixer
2. Inline Emulsifier Mixer
3. Shear Pump
4. Powder & Liquid Mixer
5. Liquid Agitator
6. Contra Rotating Mixer
7. Magnetic Agitator
8. Jet Stream Mixer
9. Vacuum Deaerator

1. High Shear Mixer

PerMix PS series High Shear Mixer is applied to achieve dispersing, homogenizing, emulsifying, and suspending functions. They work with a special designed stator/rotor working head.



Top Entry Mixer:

Model	Watts, kW	RPM, @50Hz	Max. Capacity, L		Shaft Length, mm
			@1 cPs	@3,000 cPs	
PS-X/080	1.5	3000	50	20	350
PS-X/100	2.2		100	50	600
PS-X/120	4		300	150	700
PS-X/140	7.5		800	500	800
PS-X/160	11		1500	750	820
PS-X/180	18.5		2000	1000	1100
PS-X/200	22	1500	4000	2000	1150
PS-X/220	30		5000	2500	1200
PS-X/240	37		6500	3200	1300
PS-X/270	55		10000	5000	1500
PS-X/290	75		12000	6000	1550
PS-X/300	90		15000	7500	1600

- 1) PS-C, PS-D, PS-M share the same specifications.
- 2) Actual liquid capacity will vary depending on the liquid type and different stator rotor system.
- 3) PerMix offers bigger capacity according to customer requests.
- 4) PerMix reserves the right to modify the design without notice.

1. High Shear Mixer

PerMix PS series High Shear Mixer is applied to achieve dispersing, homogenizing, emulsifying, and suspending functions. They work with a special designed stator/rotor working head.



Bottom Entry Mixer:

Model	Watts, kW	RPM, @50Hz	Max. Capacity, L		Shaft Length, mm
			@1 cPs	@3,000 cPs	
PS-B/80	1.5	3000	50	20	80
PS-B/100	2.2		100	50	100
PS-B/120	4		300	150	150
PS-B/140	7.5		1000	500	150
PS-B/160	11		1500	750	150
PS-B/180	18.5		2000	1000	180
PS-B/200	22		4000	2000	180
PS-B/220	30		5000	2500	190
PS-B/240	37	1500	6500	3200	200
PS-B/270	55		10000	5000	210
PS-B/290	75		12000	6000	210

- 1) Actual liquid capacity will vary depending on the liquid type and different stator rotor system.
- 2) PerMix offers bigger capacity according to customer requests.
- 3) PerMix reserves the right to modify the design without notice.

2. Inline Emulsifier Mixer

PerMix PC series Inline Emulsifier Mixer also works with a stator/rotor working head as the High Shear Mixer, but it is applied for inline or continuous operation.



Single stage, PC-1:

Model	Watts, kW	RPM, @50Hz	Max. Capacity	Size [DN]	
			[L/hr] @ 1 cPs	Inlet	Outlet
PC-1/60K-Ultra	4	7,500	1,500	32	25
PC-1/80K	1.5	3,000	1,500	32	25
PC-1/100K	2.2		3,000	40	32
PC-1/120K	4		4,000	40	32
PC-1/140K	5.5		5,000	50	40
PC-1/165K	7.5		8,000	50	40
PC-1/180K	11		12,000	65	50
PC-1/185K	15		18,000	65	50
PC-1/200K	22		25,000	65	50
PC-1/210K	37		35,000	80	65
PC-1/230K	45		50,000	100	80
PC-1/245K	55		75,000	100	80
PC-1/260K	75		90,000	125	100
PC-1/280K	90		110,000	125	100
PC-1/290K	132		130,000	150	125

2. Inline Emulsifier Mixer

PerMix PC series Inline Emulsifier Mixer also works with a stator/rotor working head as the High Shear Mixer, but it is applied for inline or continuous operation.

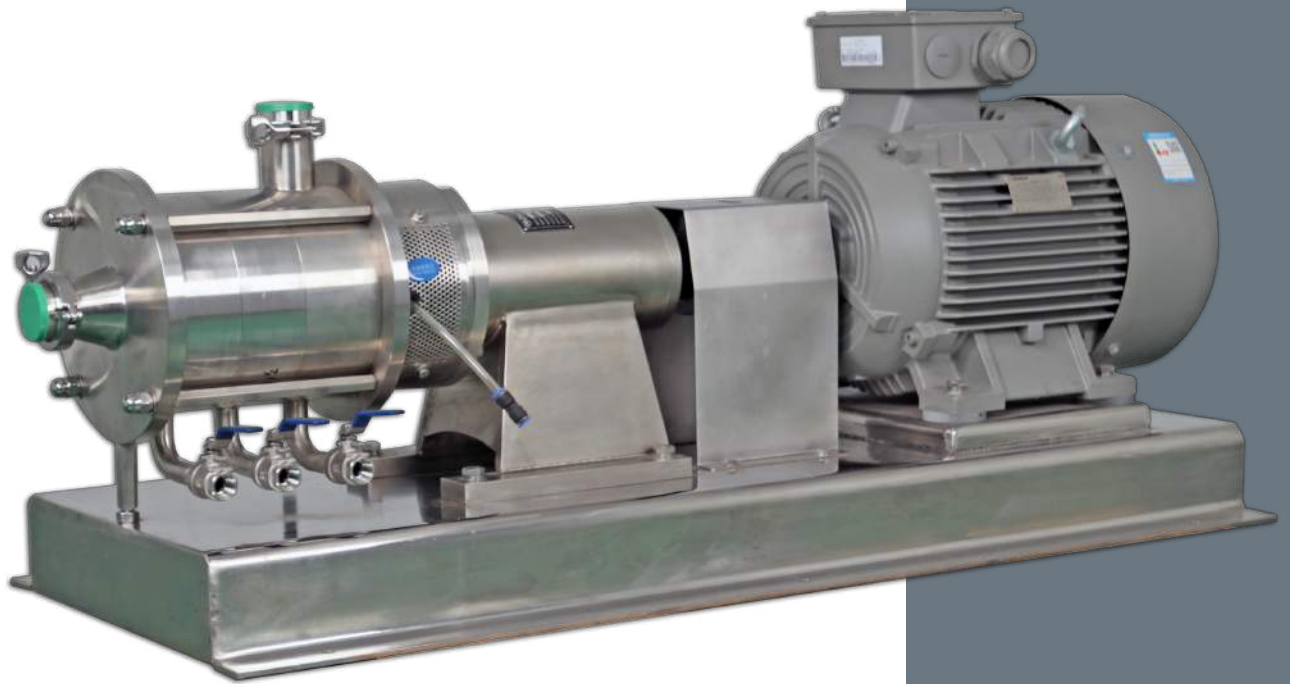

Three-stage, PC-3:

Model	Watts, kW	RPM, @50Hz	Max. Capacity	Size [DN]	
			[L/hr] @ 1 cPs	Inlet	Outlet
PC-3/80K	4	3,000	1,500	32	25
PC-3/100K	5.5		3,000	40	32
PC-3/120K	7.5		4,000	40	32
PC-3/140K	11		5,000	50	40
PC-3/165K	18.5		8,000	50	40
PC-3/180K	22		12,000	65	50
PC-3/185K	30		18,000	65	50
PC-3/200K	45		25,000	65	50
PC-3/210K	55	1,500	35,000	80	65
PC-3/230K	75		45,000	100	80
PC-3/245K	90		60,000	100	80
PC-3/260K	110		75,000	100	80
PC-3/280K	132		95,000	125	100

1. Actual liquid capacity will vary depending on the liquid type and different stator rotor system.
2. PerMix offers bigger capacity according to customer requests.
3. PerMix reserves the right to modify the design without notice.

3. Shear Pump

PerMix PCH series Hygienic Shear Pump combines the advantage of both a centrifugal pump and an inline high shear mixer. It achieves the balance of pumping efficiency and shearing energy.



Model	Motor, kW	RPM, @50Hz	Max. Liquid Capacity, L/hr	Max. Powder Capacity, Kg/min	Size [DN]	
					Inlet	Outlet
PCH-100	3-4	3,000	5,000	3	40	32
PCH-130	5.5-7.5		10,000	10	50	40
PCH-160	11-18.5		20,000	18	65	50
PCH-190	22-30		30,000	32	65	50
PCH-210	30-37		40,000	50	80	65

- 1) Actual liquid/powder capacity will vary depending on the material characters and stator rotor type.
- 2) PerMix offers bigger capacity according to customer requests.
- 3) PerMix reserves the right to modify the design without notice.

4.

Powder & Liquid Mixer

PerMix PTC series Powder Liquid Mixer is able to incorporate big volumes of powder into liquid fast and efficiently in a continuous way.



(1.1) PT-C/Q-HS (Double Wall Design), w/ High Shear Stator/Rotor

Model	Watts, kW	RPM, @50Hz	Max. Liquid Capacity, Ton/hr	Max. Powder Capacity, Kg/min
PT-C/Q-80HS	1.5	3,000	1.5	5
PT-C/Q-100HS	2.2		3	10
PT-C/Q-120HS	4		4	15
PT-C/Q-140HS	5.5		5	20
PT-C/Q-165HS	7.5		8	30
PT-C/Q-180HS	11		12	50
PT-C/Q-185HS	15		18	80
PT-C/Q-200HS	22		25	120
PT-C/Q-210HS	37		35	180
PT-C/Q-230HS	45		40	220
PT-C/Q-245HS	55		50	250
PT-C/Q-260HS	75		75	300
PT-C/Q-280HS	90		90	400
PT-C/Q-290HS	132		110	500

- 1) Actual liquid and powder capacity will vary depending on the material characters and stator rotor type.
- 2) The machine is with one (1x) pair of stator rotor.
- 3) PerMix offers special model according to customer requests.
- 4) PerMix reserves the right to modify the design without notice.

4. Powder & Liquid Mixer

PerMix PTC series Powder Liquid Mixer is able to incorporate big volumes of powder into liquid fast and efficiently in a continuous way.



(1.2) PT-C/Q-LS (Double Wall Design), w/ Low Shear Stator/Rotor

Model	Watts, kW	RPM, @50Hz	Max. Liquid Capacity, Ton/hr	Powder Capacity, Kg/min
PT-C/Q-LS1	3	3,000	15	5~20
PT-C/Q-LS2	11	1,500	25	15~60
PT-C/Q-LS3	22	1,500	40	30~120

- 1) Actual liquid and powder capacity will vary depending on the material characters.
- 2) PerMix offers special model according to customer requests.
- 3) PerMix reserves the right to modify the design without notice.

4.

Powder & Liquid Mixer

PerMix PTC series Powder Liquid Mixer is able to incorporate big volumes of powder into liquid fast and efficiently in a continuous way.



(2) PT-C/Y (Special Stator Rotor)

Model	Watts, kW	RPM, @50Hz	Max. Liquid Capacity, Ton/hr	Powder Capacity, Kg/min (with hand-held wand)
PT-C/Y-120	7.5~11	3,000	10	1~3
PT-C/Y-140	15~30		20	2~5
PT-C/Y-165	37~45		40	3~12
PT-C/Y-180	55~75	1,500	60	5~25
PT-C/Y-220	110~160		100	8~50

- 1) Actual liquid and powder capacity will vary depending on the material characters and stator rotor type.
- 2) PerMix offers special model according to customer requests.
- 3) PerMix reserves the right to modify the design without notice.

4.

Powder & Liquid Mixer

PerMix PTC series Powder Liquid Mixer is able to incorporate big volumes of powder into liquid fast and efficiently in a continuous way.

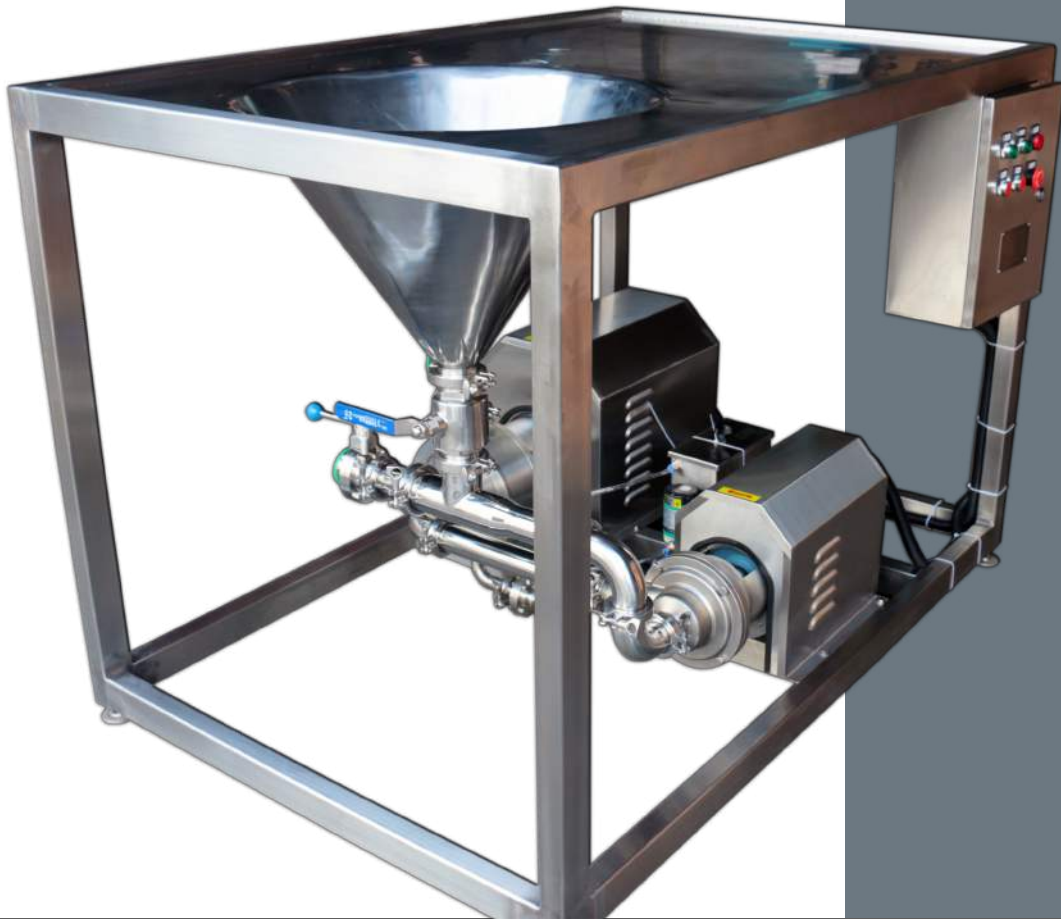

(3) PT-C/F (Two Pumps Design)

Model	Mixer, kW	RPM, @50Hz	Self-priming Pump, kW	Pump RPM, @50Hz	Max. Liquid Capacity, Ton/hr	Max. Powder Capacity, Kg/min
PT-C/F-120	4	3,000	1.5	1,500	4	15
PT-C/F-140	5.5	3,000	1.5		6	30
PT-C/F-165	7.5	3,000	4		8	50
PT-C/F-180	11	3,000	4		12	90
PT-C/F-200	22	3,000	5.5		25	140
PT-C/F-210	30	3,000	7.5		30	190

- 1) Actual liquid and powder capacity will vary depending on the material characters and stator rotor type.
- 2) PerMix offers special model according to customer requests.
- 3) PerMix reserves the right to modify the design without notice.

5. Liquid Agitator

PerMix is able to design and manufacture a comprehensive range of PA series Liquid Agitators to suit every process requirement.



6. Contra Rotating Mixer

PerMix PCR series Contra Rotating Mixers are typically used when thick emulsions are produced by a bottom entry high shear emulsifier or homogenizer.

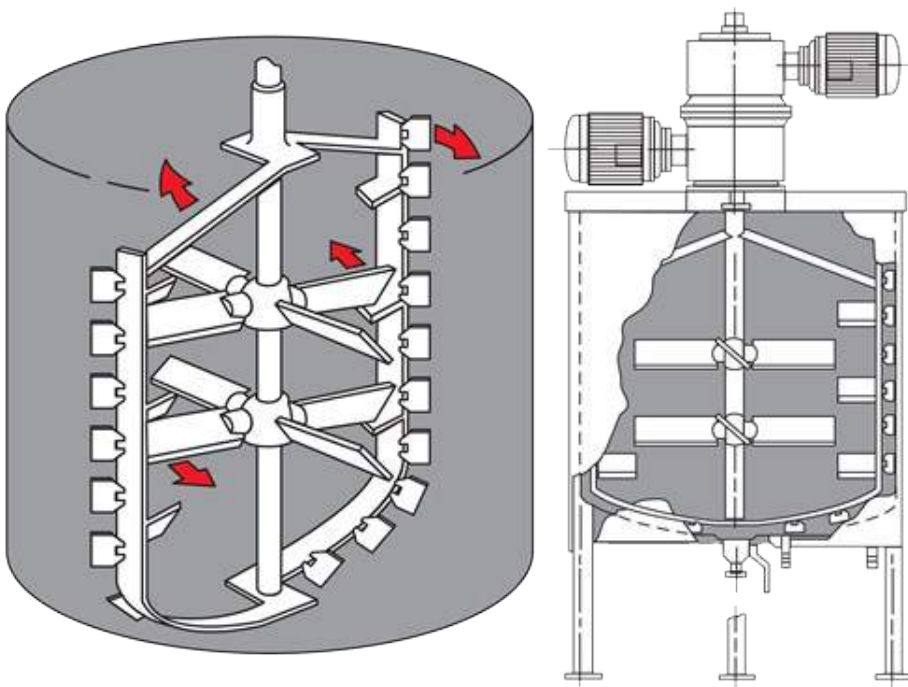

7. Magnetic Agitator

PerMix PM series Magnetic Agitator uses special magnetic driving and sealing technology to meet strict hygienic requirement or to work under hazardous conditions.

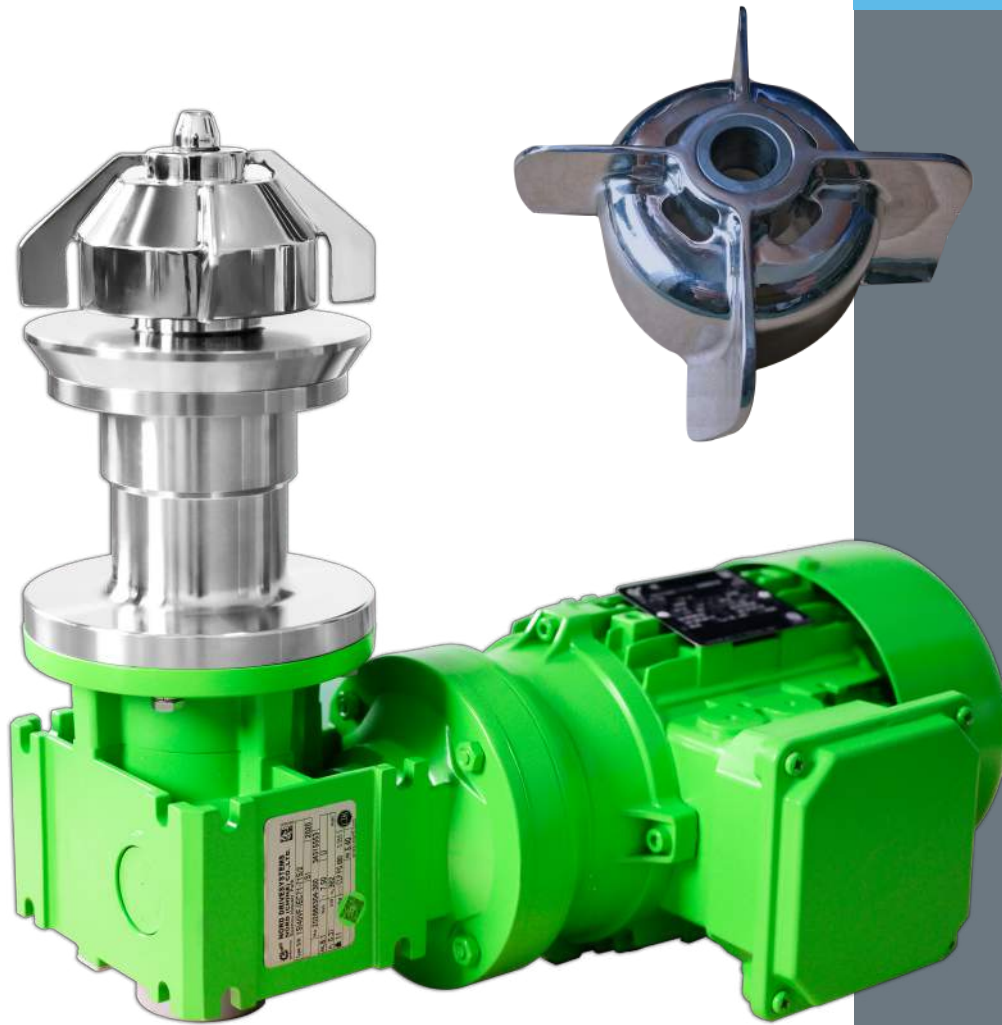

Model	Max. Capacity, Liter	Motor Power, kW	Impeller Diameter	Speed, rpm
PM-90	50	0.12	90	362
PM-120	300	0.37	120	362
PM-155	500	0.55	155	362
PM-200	1,000	0.75	200	362
PM-220	3,000	1.5	220	362
PM-240	4,000	2.2	240	362
PM-260	6,000	3	260	362
PM-320	12,000	4	320	362

- 1) Specific working volumes can be offered according to customer's requirement.
- 2) Speed can be adjusted according to customer's request.
- 3) All specifications are as accurate as is reasonably possible, but they are not binding.
- 4) PerMix reserves the right to modify the design without notice.

8.

Jet Stream Mixer

PerMix PJ series Jet Stream Mixer is used where general stirring & homogenizing, dispersing, suspending, emulsifying, dissolving are all required.



N type, Jet Agitator:

Model	Watts, kW	RPM, @50Hz	Max. Capacity, L		Shaft Length, mm
			@1 cPs	@3,000 cPs	
PJ-C/080-N	1.1-1.5	3,000	1,500	500	400-1,000
PJ-C/110-N	2.2-3		3,000	1,000	750-1,500
PJ-C/145-N	4-5.5		5,000	1,700	900-1,700
PJ-C/215-N	7.5-11	1,500	10,000	3,300	1,200-2,300
PJ-C/245-N	15-18.5		18,000	6,000	1,200-2,300
PJ-C/275-N	22-30		30,000	10,000	1,400-2,500
PJ-C/345-N	37-55		50,000	17,000	1,500-2,700

O type, Jet Dispenser:

Model	Watts, kW	RPM, @50Hz	Max. Capacity, L		Shaft Length, mm
			@1 cPs	@3,000 cPs	
PJ-C/080-O	1.5-3	3,000	100	50	350
PJ-C/100-O	2.2-4		300	150	600
PJ-C/120-O	4-7.5		800	400	700
PJ-C/140-O	7.5-15		2,000	1,000	800
PJ-C/160-O	11-18.5		3,000	1,500	820
PJ-C/180-O	18.5-30		4,000	2,000	1,100
PJ-C/200-O	22-37	1,500	5,000	2,500	1,150
PJ-C/220-O	30-45		7,000	3,500	1,200
PJ-C/240-O	37-55		12,000	6,000	1,300

- 1) Actual liquid capacity will vary depending on the liquid type and viscosity.
- 2) PerMix offers customized capacity according to customer requests.
- 3) PerMix reserves the right to modify the design without notice.

9.

Vacuum Deaerator

PerMix PDA series Vacuum Deaerator is a totally compact sanitary device designed for the continuous automatic removal of air or other occluded gases from any type of liquid or paste, by means of vacuum.



Model	Working Volume	Flowrate (Liter/hr)			Total power	L	W	H	H1, with open lid	Weight
		light liquid	viscous product	highly viscous product						
		(Liter)	(<300cPs)	(<5,000cPs)						
PDA-25	25	1,500	900	300	2.4	1,640	550	1,650	1,750	470
PDA-65	65	4,000	2,500	800	4.45	1,855	715	1,780	2,200	690
PDA-125	125	8,000	5,000	1,600	7.8	2,165	850	2,170	2,500	920
PDA-300	300	15,000	9,000	3,000	14.1	2,455	1,080	2,590	3,000	1,300
PDA-550	550	20,000	12,500	4,000	24	2,845	1,225	2,865	3,300	1,550
PDA-1200	1,200	30,000	18,000	6,000	32.5	3,455	1,850	3,675	4,180	2,180

- 1) (*) including all motors, e.g. distribution disc, vacuum pump, and discharge pump
- 2) All specifications and illustrations are as accurate as is reasonably possible, but they are not binding.
- 3) PerMix reserves the right to modify the design without notice.

Thank you!

■ PerMix in Shanghai

Room 1-1214, No.1888, N. Shengxin Rd,
Jiading District, Shanghai, 201807, China
Phone: +86 133 911 68218
Attn.: Mr. Aaron Huang
Email: aaron.h@permixtec.com

■ PerMix in Israel

230 Hazait St.,
Adi 17940, Israel
Tel: +972-54-908-0144
Attn.: Mr. Arie Srugo
Email: srugoa@permixtec.com

■ PerMix in Hong Kong

Company Name: A&A Process Equipment Co. Ltd.
Registered Address: Unit D 16/F One Capital Place,
18 Luard RD, Wan Chai, Hong Kong
VAT No.: 69776383

■ PerMix in USA

Chicago, Illinois, USA, 60601
Attn.: Mr. John Paul
Tel: +1 630-649-1357
Email: John.paul@permixtec.com

■ PerMix in South America

Buenos Aires, 1043, Argentina
Attn.: Mr. Gonzalo Villagra
Tel: +54 9 11 35374801
Email: gonzalo.villagra@permixtec.com

Besides, PerMix have been building a network of agents located in Europe (Germany, Denmark, UK, Belgium, France, Spain, Poland, etc), South America (Argentina, Chile, Guatemala, etc), Asia (South Korea, Indonesia, India), and several other countries.